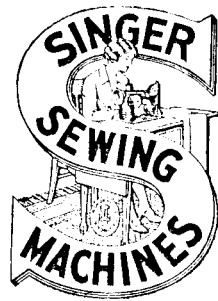


SINGER
110W117,W122

LIST OF PARTS



MACHINES Nos. 110w117 and 110w122

THE SINGER MANUFACTURING COMPANY

Instructions for Ordering

In ordering from this list, use **ONLY** the **PART** number in the **FIRST** column.

The number stamped on a Sewing Machine Part is the number of the Single Part only, except when the part includes Set Screws, Clamping Screws, Studs and Rollers Spun on, Small Wires riveted, or Parts soldered together, etc., which it is necessary to furnish in combination.

Every combination of parts sent out has its specific number which, although not stamped on Parts (except in above cases) must be used when ordering the combination.

Each number always indicates the **SAME PART** in whatever list it appears, or for whatever Machine.

The letters after some of the numbers indicate the style of finish only, as follows:

- A. Hardened, Polished and Plated.
- B. Polished and Plated.
- C. Hardened only.
- D. Polished only.
- E. Soft, not polished.
- F. Hardened and Polished.
- H. Blued.

These letters **MUST BE USED** when they appear in the list and **AFTER** the number, as in the list.

In this series

200001 to 201500 are Screw Numbers.

201501 to 201800 are Nut Numbers.

201801 to 202000 are Roller Numbers.

202001 and upward are numbers of Machine Parts.

The figures in the second column refer only to the plate in which the illustration of the part is shown and are **NOT TO BE USED** in ordering.

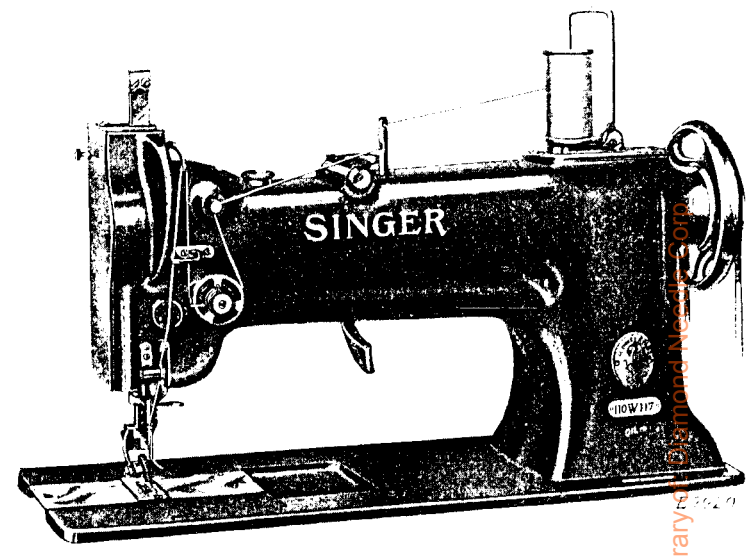
Two or more numbers over a cut indicate that the difference between such parts is not visible in an illustration.

Parts marked with an asterisk (*) are furnished only when repairs are made at the factory.

LIST OF PARTS COMPLETE
FOR

INDEX

	PAGE
ACCESSORIES	29
BORBIN WINDER	29
FEED GEARS	31
" WHEELS	32
GUIDES	32
KNEE LIFTER	36
MACHINE No. 110w117	7
" " 110w122	15
NUMERICAL LIST OF PARTS	37
THROAT PLATES	34



MACHINE No. 110w117

VERTICAL HOOK. ROLLER PRESSER.
CONTINUOUS WHEEL FEED.
VERTICAL TRIMMER

For Leather Work

No.	Plate	Name
*237801	-	Arm
203091	14196	" Cap
200278n	14176	" " Screw
202248	14176	" " Washer
203089	14196	" " Spool Holder Base
203090	14196	" " " " " 203089 with 200079n and 204296
200585n	14187	Arm Cap Spool Holder Base Screw
204296	14196	" " " " Wire
200079n	14187	" " " " " Hinge Screw

From the library of www.indianmuseum.com

No.	Plate	Name
203092	---	Arm Cap and Spool Holder complete, Nos. 203090, 203091 and two 200585n
204235	14187	Arm Position Pin (2)
200004E	14176	" Screw
200010E	14176	" " (2)
202005	14176	" " Washer (3)
202632	14196	" Side Plate
200462B	14176	" " " Thumb Screw
237802	14197	" Shaft with 200357E and 203100
237748	14196	" " Bushing (back) with 202299
202299	---	Arm Shaft Bushing (back) Oil Packing (wick)
200071E	14176	Arm Shaft Bushing (back) Screw (3)
207080	14196	Arm Shaft Bushing (front) with 202244
202244	----	Arm Shaft Bushing (front) Oil Packing (wick)
200502B	14176	Arm Shaft Bushing (front) Oil Packing Thumb Screw
200338C	14176	Arm Shaft Bushing (front) Set Screw
203100	----	Arm Shaft Oil Packing (wick)
200357E	14176	" " " " Stop Screw...
223842	14197	Balance Wheel (belt groove 23 in. diam.) with 200328C and 200335C
200062H	14176	Balance Wheel Adjusting Screw...
200328C	14176	" " Position Screw ...
200335C	14176	" " Set Screw
*237834	---	Bed
237901	14196	" Slide (back)
237835	14196	" " (front)
203470	14176	Bobbin
*203520	---	" Case
203648	14176	" " Latch
*202056	---	" " " Pin
203473	14176	" " " Plunger
203474	14176	" " " Spring
236078	14176	" " Lever
*203476	----	" " Eccentric
204243	14176	" " " Position Pin
235751	14176	" " " Fulcrum
200056D	10884	" " " Screw
203478	14176	" " " Slide Stud
203214	14176	" " Tension Spring
200981C	14176	" " " " Regulat- ing Screw

No.	Plate	Name
200594C	14176	Bobbin Case Tension Spring Screw
203216	-	" " Washer (cloth)
203521	14176	Bobbin Case complete, Nos. 200594C, 200984C, 202056, 203214, 203216, 203473, 203474, 203520 and 203648
237804	14197	Face Plate
202135	14176	" " Position Pin
200473B	14176	" " Thumb Screw
237707	14190	Feed Wheel
350085F	14398	" " Adjusting Screw
237708	14398	" " " " Block
238603	14400	" " Bracket with 238630 ..
238604	14400	" " " Plate
200158B	14398	" " " " Screw (2)
237710	14398	" " " Spring
238608	----	" " Driving Gear (for 16 stitches)
238609	14403	Feed Wheel Driving Gear (for 17½ stitches)
238610	-	Feed Wheel Driving Gear (for 19 stitches)
238613	14398	Feed Wheel Driving Gear Key
238614	14398	" " " " " Shift- ing Collar with 201464C
201464C	14187	Feed Wheel Driving Gear Key Shift- ing Screw Stud
238615	14398	Feed Wheel Driving Gear Key Spring
201202D	14398	Feed Wheel Driving Gear Key Spring Screw
238616	14398	Feed Wheel Driving Gear Key Stop Pin
238617	14398	Feed Wheel Driving Gear Separat- ing Washer
238621	----	Feed Wheel Driving Pinion (for 16 stitches)
238622	14403	Feed Wheel Driving Pinion (for 17½ stitches)
238623	----	Feed Wheel Driving Pinion (for 19 stitches)
231433	14398	Feed Wheel Driving Pinion Key ..
238632	14403	" " " " Spacing Washer (for use in place of Feed Wheel Driving Pinion when one or two lengths of stitch are required)
238627	14197	Feed Wheel Driving Shaft
237722	14400	" " " " Bushing (back)

No.	Plate	Name
238628	14400	Feed Wheel Driving Shaft Bushing (front)
200362c	14398	Feed Wheel Driving Shaft Bushing Set Screw
221743	14398	Feed Wheel Driving Shaft Collar with two 200380c
200380c	14398	Feed Wheel Driving Shaft Collar Set Screw
237724	14400	Feed Wheel Driving Shaft Gear with 200378c and 201220c
201220c	14187	Feed Wheel Driving Shaft Gear Position Screw
200378c	14398	Feed Wheel Driving Shaft Gear Set Screw
201666E	14198	Feed Wheel Driving Shaft Nut ...
203411	14398	" " " " Washer
238629	14398	" " Stud with 238616
238630	14398	" " " Bushing
238631	14398	" " " Collar with 200152H
200152H	14398	" " " " Pinch Screw
201697c	14398	" " " Nut
*203482	---	Hook (sewing)
203483	---	" 203482 with 201253E, 201376E and 203251
203547	---	Hook and Bobbin Case complete, Nos. 203483 and 203521
235755	14181	Hook Bevel Gear Socket, 18 teeth..
235527	14181	" " " " Bushing (lower) (brass)
200362c	14398	Hook Bevel Gear Socket Bushing (lower) Set Screw
235756	14181	Hook Bevel Gear Socket Bushing (upper) (brass)
449c	14181	Hook Bevel Gear Socket Bushing (upper) Set Screw
200555H	14181	Hook Bevel Gear Socket Screw ..
235635	14181	" " " " Thrust Washer
235529	14181	Hook Driving Bevel Gear with two 350089c
350089c	14181	Hook Driving Bevel Gear Set Screw
237728	14190	" " Shaft
235857	14181	" " " Bevel Gear with 200374c and 200396c
237729	14197	Hook Driving Shaft Bevel Gear Housing with 200346c and three 200362c
237730	14400	Hook Driving Shaft Bevel Gear Housing Cap (bottom)

No.	Plate	Name
237731	14400	Hook Driving Shaft Bevel Gear Housing Cap (bottom) Gasket ..
237732	14400	Hook Driving Shaft Bevel Gear Housing Cap (side)
237733	14400	Hook Driving Shaft Bevel Gear Housing Cap (side) Gasket
200053c	14181	Hook Driving Shaft Bevel Gear Housing Cap Screw (4)
201082E	14181	Hook Driving Shaft Bevel Gear Housing Screw (long)
225532	14187	Hook Driving Shaft Bevel Gear Housing Screw (long) Washer..
201308E	14181	Hook Driving Shaft Bevel Gear Housing Screw (short)
200396c	11607	Hook Driving Shaft Bevel Gear Position Screw
200374c	14181	Hook Driving Shaft Bevel Gear Set Screw
237734	14181	Hook Driving Shaft Bushing (back)
200362c	14398	" " " " " Set Screw
235531	14181	Hook Driving Shaft Bushing (front)
200347c	14181	" " " " " Set Screw
221743	14398	Hook Driving Shaft Collar with two 200380c
200380c	14398	Hook Driving Shaft Collar Set Screw
203251	---	Hook Gib
201376E	14181	" " Hinge Screw
201253E	14181	" " Screw
237735	14197	" Saddle with 449c, 200347c and three 200362c
235534	14400	Hook Saddle Oil Cover
201185D	14399	" " " " Screw (2)..
201318E	14399	" " " Stop Screw (2)..
235535	---	" " Oiling Felt
202260	---	" " " Wick
235649	14399	" " " " Cover
200169H	14399	" " " " " Screw
201308E	14181	" " Screw (2)
203637	---	" " " Washer (2)
213018	14399	" Washer with 203476 and two 204243
208490	14190	Knee Lifter Connection Lever
200262H	14399	" " " " Hinge Screw
237766	14190	Knee Lifter Connection Lever Lifting Rod with 202302

No.	Plate	Name
202302	14399	Knee Lifter Connection Lever Lifting Rod Cotter Pin
237805	14197	Knee Lifter Lifting Lever
200262H	14399	" " " " Hinge Screw
207805	14187	Knife
200397H	11610	" Adjusting Screw
237806	14190	" Bar
237807	14187	" " Angle Extension
200126E	14187	" " " " Screw (2)
221417	14190	" " Driving Eccentric with 200382c and 200437c
202890	14190	Knife Bar Driving Eccentric Fork with 200382c and 201464c
201464c	14187	Knife Bar Driving Eccentric Fork Position Screw
200382c	14198	Knife Bar Driving Eccentric Fork Set Screw
200437c	14187	Knife Bar Driving Eccentric Position Screw
200382c	14198	Knife Bar Driving Eccentric Set Screw
202891	14192	Knife Bar Driving Shaft Crank with 200694F and 201525E
203244	14187	Knife Bar Driving Shaft Crank Collar with two 200393c
200393c	14187	Knife Bar Driving Shaft Crank Collar Set Screw
200694F	14187	Knife Bar Driving Shaft Crank Screw Stud
201525E	14187	Knife Bar Driving Shaft Crank Screw Stud Nut
237808	14187	Knife Bar Guide Block
200011E	14187	" " " " Screw (2)
200337c	14187	" " " Screw
201531E	14187	" " " " Nut
237829	14187	" " Lifting Spring
202346	14187	" " " " Plunger
237809	14198	" " Position Bracket
201387F	14198	" " " " Screw (2)
237810	14198	" Holder with 200397H
200898D	14198	" " Screw
237811	14198	" " Switch-in Handle
200076D	14198	" Screw (2)
237812	14192	" Switch-out Handle with two 200403c
200403c	----	Knife Switch-out Handle Set Screw
202899	14192	" " " Shaft
202900	14198	" " " Spring (spiral)

No.	Plate	Name
237822	14192	Needle Bar with 200389c
202552	11607	" " Connecting Link
236073	14399	" " " " Oil Guard
200161D	11607	Needle Bar Connecting Link Oil Guard Screw
202333	11607	Needle Bar Connecting Link Stud with 202254
202254	----	Needle Bar Connecting Link Stud Oil Packing (wick)
200374c	14181	Needle Bar Connecting Link Stud Set Screw
200383c	14399	Needle Bar Connecting Link Stud Set Screw
*206891	----	Needle Bar Connecting Stud
202329	11607	" " " " 206891 with 200086c and 202330
202330	----	Needle Bar Connecting Stud Oil Packing (wick)
200086c	11607	Needle Bar Connecting Stud Lock Screw
202692	14192	Needle Bar Crank with 200335c, 200374c, 200383c, 200428c and 202333
237737	----	Needle Bar Crank 202692 with 202329, 202399, 202400, 20255F and 237762
203172	11607	Needle Bar Crank Friction Washer
200428c	11607	" " " Position Screw
200335c	14176	" " " Set Screw
237813	14192	" " Rock Frame
237814	----	" " " " 237813 with 237822
*38127	----	Needle Bar Rock Frame Driving Eccentric
*237749	----	Needle Bar Rock Frame Driving Eccentric Body
350107c	14399	Needle Bar Rock Frame Driving Eccentric Body Position Screw
443c	14399	Needle Bar Rock Frame Driving Eccentric Body Set Screw
1103c	14399	Needle Bar Rock Frame Driving Eccentric Regulating Screw
217D	14399	Needle Bar Rock Frame Driving Eccentric Set Screw
7071	14399	Needle Bar Rock Frame Driving Eccentric Set Screw Washer

No.	Plate	Name
237750	---	Needle Bar Rock Frame Driving Eccentric complete. Nos. 217b, 443c, 1103c, 7071, 38127, 237749 and 350107c
237739	14192	Needle Bar Rock Frame Driving Fork Lever with 200029E
200029E	14399	Needle Bar Rock Frame Driving Fork Lever Pinch Screw
237740	14403	Needle Bar Rock Frame Driving Fork Lever Slide Block (two pieces)
210910	11607	Needle Bar Rock Frame Hinge Stud with 202277
202277	---	Needle Bar Rock Frame Hinge Stud Oil Packing (wick)
200347c	14181	Needle Bar Rock Frame Hinge Stud Set Screw
202667	14192	Needle Bar Rock Frame Rock Shaft
210978	---	" " " " " "
		202667 with 200386c and 210920..
237815	14198	Needle Bar Rock Frame Position Bracket with 200337c and 201531E
350129E	14198	Needle Bar Rock Frame Position Bracket Screw (2)
202668	11607	Needle Bar Rock Frame Slide Block
210920	---	" " " " " "
		202668 with 201141c
201141c	14399	Needle Bar Rock Frame Slide Block Screw Stud
200386c	14199	Needle Bar Rock Frame Slide Block Screw Stud Set Screw
200389c	11610	Needle Set Screw
207072	11607	Presser Bar Bushing (2)
200352c	14198	" " " Set Screw
202671	14399	" " Lifter
200653c	14198	" " Hinge Screw
207963	14399	" " Lifting Releasing Lever Bracket
200975E	14198	Presser Bar Lifting Releasing Lever Bracket Guide Screw
206608	14198	Presser Bar Lifting Releasing Lever Bracket Spring
237820	14198	Presser Bar Position Guide
202338	14198	" " " " Lever with 200086E
200086E	11607	Presser Bar Position Guide Lever Pinch Screw
200352c	14198	Presser Bar Position Guide Set Screw

No.	Plate	Name
237821	14197	Presser Bar Spring (flat)
210949	14193	" " " Bracket with 200086c
200086c	11607	Presser Bar Spring Bracket Pinch Screw
200538c	14193	Presser Bar Spring Regulating Screw
200948E	14193	Presser Bar Spring Support Screw
201954	---	Roller Presser, 3/8 in. diam., 3/4 in. face
201955	14193	Roller Presser 201954 with 1528J, 201699c, 350104c and twenty-eight 206417
203422	14193	Roller Presser Arm
237816	---	" " " 203422 with 201955
202560	14193	Roller Presser Arm Bracket (swing)
237817	---	" " " " 202560 with 200096c and 237816
200675c	14193	Roller Presser Arm Bracket Position Screw Stud
202558	14193	Roller Presser Arm Bracket Spring
202559	14193	" " " " " "
		Stop
200141E	11607	Roller Presser Arm Bracket Spring Stop Screw
200096c	14193	Roller Presser Arm Screw
206417	14193	" " Ball, 3/8 in. diameter
201699c	14193	" " " Cone
202557	14192	" " Bar
350104c	14193	" " Hinge Screw
1528J	14193	" " " " Nut
237818		Roller Presser and Bar complete. Nos. 200675c, 202557 to 202559, 237817 and two 200141E
237762	14193	Take up Lever
202399	14193	" " Driving Stud with 202277
202277	-	Take up Lever Driving Stud Oil Packing (wick)
202400	14193	Take-up Lever Hinge Stud with 202423
202423	-	Take-up Lever Hinge Stud Oil Packing (wick)
200363c	14193	Take-up Lever Hinge Stud Set Screw
202401		Take-up Lever Oiling Felt
200132E	14193	" " " " Screw

No.	Plate	Name
244007	----	Tension Disc (back)
207964	----	“ “ (front)
210950	14193	“ Release Driving Lever with 200394c and 202676
202676	14193	Tension Release Driving Lever Pin
237819	14193	“ “ “ “ “ Slide Bar
237828	—	Tension Release Driving Lever Pin Slide Bar 237819 with 200167r and 210952
202678	14193	Tension Release Driving Lever Pin Slide Bar Spring
200394c	14198	Tension Release Driving Lever Set Screw
210951	11610	Tension Release Washer
202407	10881	“ Spring
200625F	11610	“ Stud with 204925
200061c	14198	“ “ Set Screw
204925	11610	“ “ Washer
201572B	10881	“ Thumb Nut
210953	11610	Tension complete, Nos. 200625F, 201572B, 202407, 202682, 207964, 210951 and 244007
202682	11610	Thread Controller Spring
210952	11610	“ “ “ Stop
200167E	11610	“ “ “ “ Screw
202412	14199	“ Guide
210955	11610	“ “ (upper)
200582H	11610	“ “ Screw (2)
204329	----	“ Oiler (felt)
237770	14199	“ “ Bracket with 204329 ...
200582H	11610	“ “ “ Screw
210956	11610	“ Retainer Bracket with 200397H
200582H	11610	“ “ “ Screw (2) ..
202091	14199	“ “ Sleeve
210993	11610	“ “ “
202092	14199	“ “ Spring
223844	14199	“ “ “
204058	14199	“ “ Stud
210957	11610	“ “ “
210958	11610	“ “ “ Collar
200366H	14199	“ “ “ Set Screw
200397H	11610	“ “ “ “ “
210959	11610	Thread Retainer (lower) complete, Nos. 210956 to 210958, 210993 and 223844
204059	----	Thread Retainer (upper) complete, Nos. 202091, 202092 and 204058...

No.	Plate	Name
237823	14200	Throat Plate, 53 elongated needle hole, for needle sizes 14 and 15, with 200178b, 200587b, 211416 and 211424, trim opposite the needle and .045, .060 and .085 in. to right of seam
211424	14200	Throat Plate Knife Follower
200587b	14199	“ “ “ “ Screw ..
211416	14200	“ “ “ “ Spring
200178b	14199	“ “ “ “ “ Screw
691F	14199	Throat Plate Screw (2)
237744	14192	Vertical Shaft
237745	14199	“ “ Bevel Gear (lower)
205508	14199	“ “ “ “ “ Position Pin
235857	14181	Vertical Shaft Bevel Gear (upper) with 200374c and 200396c
200396c	11607	Vertical Shaft Bevel Gear (upper) Position Screw
200374c	14181	Vertical Shaft Bevel Gear (upper) Set Screw
237734	14181	Vertical Shaft Bushing (lower) ..
200346c	14199	“ “ “ “ Set Screw
237746	14192	Vertical Shaft Bushing (upper) ..
200362c	14398	“ “ “ “ Set Screw
237747	14199	Vertical Shaft Driving Gear with 200374c and 200396c
200396c	11607	Vertical Shaft Driving Gear Position Screw
200374c	14181	Vertical Shaft Driving Gear Set Screw
237754	14199	Vertical Shaft Oil Leader (lower) (brass)
237755	14199	Vertical Shaft Oil Leader (upper) (brass)

From the library of: Diamond Needle Corp

LIST OF PARTS COMPLETE
FOR
MACHINE No. 110w122

VERTICAL HOOK. ROLLER PRESSER.
 CONTINUOUS WHEEL FEED.
 UNDEREDGE TRIMMER

For Leather Work

No.	Plate	Name
*237801	----	Arm
203091	14196	" Cap
200278n	14176	" " Screw
202248	14176	" " " Washer
203089	14196	" " Spool Holder Base
203090	14196	" " " " " 203089 with 200079n and 204296
200585n	14187	Arm Cap Spool Holder Base Screw
204296	14196	" " " " Wire
200079n	14187	" " " " " Hinge Screw
203092	----	Arm Cap and Spool Holder complete, Nos. 203090, 203091 and two 200585n
204235	14187	Arm Position Pin (2)
200004e	14176	" Screw
200010e	14176	" " (2)
202005	14176	" " Washer (3)
202632	14196	" Side Plate
200462n	14176	" " " Thumb Screw
237802	14197	" Shaft with 200357e and 203100
237748	14196	" " Bushing (back) with 202299
202299	----	Arm Shaft Bushing (back) Oil Packing (wick)
200071e	14176	Arm Shaft Bushing (back) Screw (3)
207080	14196	Arm Shaft Bushing (front) with 202244
202244	----	Arm Shaft Bushing (front) Oil Packing (wick)
200502n	14176	Arm Shaft Bushing (front) Oil Packing Thumb Screw

No.	Plate	Name
200338e	14176	Arm Shaft Bushing (front) Set Screw
203100	----	Arm Shaft Oil Packing (wick) ...
200357e	14176	" " " " Stop Screw ..
223842	14197	Balance Wheel (belt groove 2½ in. diam.) with 200328e and 200335e
200062n	14176	Balance Wheel Adjusting Screw ..
200328e	14176	" " Position Screw ...
200335e	14176	" " Set Screw
*237834	----	Bed
237901	14196	" Slide (back)
237959	14196	" " (front)
203470	14176	Bobbin
*203520	----	" Case
203648	14176	" " Latch
*202056	----	" " " Pin
203473	14176	" " " Plunger
203474	14176	" " " Spring
236078	14176	" " Lever
*203476	----	" " " Eccentric
204243	14176	" " " " Position Pin
235751	14176	" " " Fulcrum
200056n	10884	" " " " Screw
203478	14176	" " " Slide Stud
203214	14176	" " Tension Spring
200984c	14176	" " " " Regulat- ing Screw
200594c	14176	Bobbin Case Tension Spring Screw
203216	----	" " Washer (cloth)
203521	14176	Bobbin Case complete, Nos. 200594c, 200984c, 202056, 203214, 203216, 203473, 203474, 203520 and 203648
237804	14197	Face Plate
202135	14176	" " Position Pin
200473n	14176	" " Thumb Screw
237707	14190	Feed Wheel
350085e	14398	" " Adjusting Screw
237708	14398	" " " " Block ..
238603	14400	" " Bracket with 238630 ..
238604	14400	" " " Plate
200158n	14398	" " " " Screw (2)
237710	14398	" " " Spring
238608	----	" " Driving Gear (for 16 stitches)
238609	14403	Feed Wheel Driving Gear (for 17½ stitches)
238610	----	Feed Wheel Driving Gear (for 19 stitches)

No.	Plate	Name
238613	14398	Feed Wheel Driving Gear Key
238614	14398	" " " " " Shift- ing Collar with 201464c
201464c	14187	Feed Wheel Driving Gear Key Shifting Collar Screw Stud
238615	14398	Feed Wheel Driving Gear Key Spring
201202d	14398	Feed Wheel Driving Gear Key Spring Screw
238616	14398	Feed Wheel Driving Gear Key Stop Pin
238617	14398	Feed Wheel Driving Gear Separat- ing Washer
238621	---	Feed Wheel Driving Pinion (for 16 stitches)
238622	14403	Feed Wheel Driving Pinion (for 17½ stitches)
238623	---	Feed Wheel Driving Pinion (for 19 stitches)
231433	14398	Feed Wheel Driving Pinion Key ..
238632	14403	" " " " Spacing Washer (for use in place of Feed Wheel Driving Pinion when one or two lengths of stitch are re- quired)
238627	14197	Feed Wheel Driving Shaft
237722	14400	" " " " Bushing (back)
238628	14400	Feed Wheel Driving Shaft Bushing (front)
200362c	14398	Feed Wheel Driving Shaft Bushing Set Screw
221743	14398	Feed Wheel Driving Shaft Collar with two 200380c
200380c	14398	Feed Wheel Driving Shaft Collar Set Screw
237724	14400	Feed Wheel Driving Shaft Gear with 200378c and 201220c
201220c	14187	Feed Wheel Driving Shaft Gear Position Screw
200378c	14398	Feed Wheel Driving Shaft Gear Set Screw
201666E	14198	Feed Wheel Driving Shaft Nut ...
203411	14398	" " " " Washer
238629	14398	" " Stud with 238616
238630	14398	" " " Bushing
238631	14391	" " " Collar with 200152H
200152H	14398	" " " " Pinch Screw
201697c	14398	" " " Nut

No.	Plate	Name
*203482	---	Hook (sewing)
203483	---	" 203482 with 201253E, 201376E and 203251
203547	---	Hook and Bobbin Case complete, Nos. 203483 and 203521
235755	14181	Hook Bevel Gear Socket, 18 teeth..
235527	14181	" " " " Bushing (lower) (brass)
200362c	14398	Hook Bevel Gear Socket Bushing (lower) Set Screw
235756	14181	Hook Bevel Gear Socket Bushing (upper) (brass)
449c	14181	Hook Bevel Gear Socket Bushing (upper) Set Screw
200555H	14181	Hook Bevel Gear Socket Screw ..
235635	14181	" " " " Thru Nut Washer
235529	14181	Hook Driving Bevel Gear with two 350089c
350089c	14181	Hook Driving Bevel Gear Set Screw
237728	14190	" " Shaft
235857	14181	" " " Bevel Gear with 200374c and 200396c
237729	14197	Hook Driving Shaft Bevel Gear Housing with 200346c and three 200362c
237730	14400	Hook Driving Shaft Bevel Gear Housing Cap (bottom)
237731	14400	Hook Driving Shaft Bevel Gear Housing Cap (bottom) Gasket ..
237732	14400	Hook Driving Shaft Bevel Gear Housing Cap (side)
237733	14400	Hook Driving Shaft Bevel Gear Housing Cap (side) Gasket
200053c	14181	Hook Driving Shaft Bevel Gear Housing Cap Screw (4)
201082E	14181	Hook Driving Shaft Bevel Gear Housing Screw (long)
225532	14187	Hook Driving Shaft Bevel Gear Housing Screw (long) Washer ..
201308E	14181	Hook Driving Shaft Bevel Gear Housing Screw (short)
200396c	11607	Hook Driving Shaft Bevel Gear Position Screw
200374c	14181	Hook Driving Shaft Bevel Gear Set Screw
237734	14181	Hook Driving Shaft Bushing (back)
200362c	14398	" " " " " " Set Screw

No.	Plate	Name
235531	14181	Hook Driving Shaft Bushing (front)
200347c	14181	" " " " "
		Set Screw
221743	14398	Hook Driving Shaft Collar with two
		200380c
200380c	14398	Hook Driving Shaft Collar Set
		Screw
203251	----	Hook Gib
201376F	14181	" " Hinge Screw
201253F	14181	" " Screw
237735	14197	" Saddle with 449c, 200347c and
		three 200362c
235534	14400	Hook Saddle Oil Cover
201185D	14399	" " " " Screw (2) ..
201318E	14399	" " " Stop Screw (2) ..
235535	----	" " Oiling Felt
202260	----	" " Wick
235649	14399	" " " " Cover
200169H	14399	" " " " Screw
201308E	14181	" " Screw (2)
203637	----	" " Washer (2)
213018	14399	" Washer with 203476 and two
		204243
208490	14190	Knee Lifter Connection Lever
200262H	14399	" " " " Hinge
		Screw
237766	14190	Knee Lifter Connection Lever Lift-
		ing Rod with 202302
202302	14399	Knee Lifter Connection Lever Lift-
		ing Rod Cotter Pin
237805	14197	Knee Lifter Lifting Lever
200262H	14399	" " " " Hinge
		Screw
207807	14187	Knife
200368H	14187	" Adjusting Screw
237932	14190	" Bar
237807	14187	" " Angle Extension
200126E	14187	" " " " Screw (2)
221417	14190	" " Driving Eccentric with
		200382c and 200437c
202890	14190	Knife Bar Driving Eccentric Fork
		with 200382c and 201464c
201464c	14187	Knife Bar Driving Eccentric Fork
		Position Screw
200382c	14198	Knife Bar Driving Eccentric Fork
		Set Screw
200437c	14187	Knife Bar Driving Eccentric Posi-
		tion Screw
200382c	14198	Knife Bar Driving Eccentric Set
		Screw

No.	Plate	Name
202891	14192	Knife Bar Driving Shaft Crank with
		200694F and 201525E
202244	14187	Knife Bar Driving Shaft Crank
		Collar with two 200393c
200393c	14187	Knife Bar Driving Shaft Crank
		Collar Set Screw
200694F	14187	Knife Bar Driving Shaft Crank
		Screw Stud
201525E	14187	Knife Bar Driving Shaft Crank
		Screw Stud Nut
237907	14187	Knife Bar Guide Block
200011E	14187	" " " " Screw (2) ..
200404c	14187	" " " Screw
201531E	14187	" " " " Nut
237829	14187	" " Lifting Spring
202346	14187	" " " " Plunger ..
237908	14198	" " Position Bracket
201387F	14198	" " " " Screw
		(2)
237933	14198	Knife Holder with 200368H
200898c	14198	" " Screw
237939	14198	" " Switch-in Handle
200076D	14198	" Screw (2)
237812	14192	" Switch-out Handle with two
		200403c
200403c	----	Knife Switch-out Handle Set Screw
202899	14192	" " " Shaft
202900	14198	" " " Spring
		(spiral)
237937	14399	Needle Bar with 200141E
202552	11607	" " Connecting Link
236073	14399	" " " " Oil
		Guard
200161D	11607	Needle Bar Connecting Link Oil
		Guard Screw
202333	11607	Needle Bar Connecting Link Stud
		with 202254
202254	----	Needle Bar Connecting Link Stud
		Oil Packing (wick)
200374c	14181	Needle Bar Connecting Link Stud
		Set Screw
200383c	14399	Needle Bar Connecting Link Stud
		Set Screw
*206891	----	Needle Bar Connecting Stud
202329	11607	" " " " 206891
		with 200086c and 202330
202330	----	Needle Bar Connecting Stud Oil
		Packing (wick)
200086c	11607	Needle Bar Connecting Stud Pinch
		Screw

No.	Plate	Name
202692	14192	Needle Bar Crank with 200335c, 200374c, 200383c, 200428c and 202333
237737	----	Needle Bar Crank 202692 with 202329, 202399, 202400, 202552 and 237762
203172	11607	Needle Bar Crank Friction Washer
200428c	11607	" " " Position Screw ..
200335c	14176	" " " Set Screw
237813	14192	" " Rock Frame
237931	----	" " " " 237813 with 237937
*38127	----	Needle Bar Rock Frame Driving Eccentric
*237749	----	Needle Bar Rock Frame Driving Eccentric Body
350107c	14399	Needle Bar Rock Frame Driving Eccentric Body Position Screw ..
443c	14399	Needle Bar Rock Frame Driving Eccentric Body Set Screw
1103c	14399	Needle Bar Rock Frame Driving Eccentric Regulating Screw
217d	14399	Needle Bar Rock Frame Driving Eccentric Set Screw
7071	14399	Needle Bar Rock Frame Driving Eccentric Set Screw Washer ...
237750	----	Needle Bar Rock Frame Driving Eccentric complete, Nos. 217d, 443c, 1103c, 7071, 38127, 237749 and 350107c
237739	14192	Needle Bar Rock Frame Driving Fork Lever with 200029e
200029e	14399	Needle Bar Rock Frame Driving Fork Lever Pinch Screw
237740	14403	Needle Bar Rock Frame Driving Fork Lever Slide Block (two pieces)
210910	11607	Needle Bar Rock Frame Hinge Stud with 202277
202277	----	Needle Bar Rock Frame Hinge Stud Oil Packing (wick)
200347c	14181	Needle Bar Rock Frame Hinge Stud Set Screw
202667	14192	Needle Bar Rock Frame Rock Shaft
210978	----	" " " " " " " " 202667 with 200386c and 210920 ..
237910	14198	Needle Bar Rock Frame Position Bracket with 200404c and 201531e
350129e	14198	Needle Bar Rock Frame Position Bracket Screw (2)

No.	Plate	Name
202668	11607	Needle Bar Rock Frame Slide Block
210920	----	" " " " " " " " 202668 with 201141c
201141c	14399	Needle Bar Rock Frame Slide Block Screw Stud
200386c	14199	Needle Bar Rock Frame Slide Block Screw Stud Set Screw
200141e	11607	Needle Set Screw
207072	11607	Presser Bar Bushing (2)
200352c	14198	" " " Set Screw (2) ..
202671	14399	" " Lifter
200653c	14198	" " " Hinge Screw
207963	14399	" " Lifting Releasing Lever Bracket
200975e	14198	Presser Bar Lifting Releasing Lever Bracket Guide Screw
206608	14198	Presser Bar Lifting Releasing Lever Bracket Spring
237820	14198	Presser Bar Position Guide
202338	14198	" " " " Lever with 200086e
200086e	11607	Presser Bar Position Guide Lever Pinch Screw
200352c	14198	Presser Bar Position Guide Set Screw
237821	14197	Presser Bar Spring (flat)
210949	14193	" " " Bracket with 200086c
200086c	11607	Presser Bar Spring Bracket Pinch Screw
200538c	14193	Presser Bar Spring Regulating Screw
200948e	14193	Presser Bar Spring Support Screw
201954	----	Roller Presser, $\frac{11}{16}$ in. diam., $\frac{3}{8}$ in. face
201955	14193	Roller Presser 201954 with 1528a, 201699c, 350104c and twenty-eight 206417
203422	14193	Roller Presser Arm
237816	----	" " " " 203422 with 201955
202560	14193	Roller Presser Arm Bracket (swing)
237817	----	" " " " " " 202560 with 200096d and 237816
200675c	14193	Roller Presser Arm Bracket Position Screw Stud
202558	14193	Roller Presser Arm Bracket Spring
202559	14193	" " " " " " " " Stop

No.	Plate	Name
200141F	11607	Roller Presser Arm Bracket Spring Stop Screw
200096D	14193	Roller Presser Arm Screw
206417	14193	" " Ball, $\frac{1}{16}$ in. diameter..
201699C	14193	" " " Cone
202557	14192	" " Bar
350104C	14193	" " Hinge Screw
1528J	14193	" " " Nut
237818	—	Roller Presser and Bar complete, Nos. 200675C, 202557 to 202559, 237817 and two 200141F
237762	14193	Take-up Lever
202399	14193	" " Driving Stud with 202277
202277	—	Take-up Lever Driving Stud Oil Packing (wick)
202400	14193	Take-up Lever Hinge Stud with 202423
202423	—	Take-up Lever Hinge Stud Oil Packing (wick)
200363C	14193	Take-up Lever Hinge Stud Set Screw
202401	—	Take-up Lever Oiling Felt
200132E	14193	" " " " Screw
244007	—	Tension Disc (back)
207964	—	" " (front)
210950	14193	" Release Driving Lever with 200394C and 202676
202676	14193	Tension Release Driving Lever Pin
237819	14193	" " " " " " Slide Bar
237828	—	Tension Release Driving Lever Pin Slide Bar 237819 with 200167E and 210952
202678	14193	Tension Release Driving Lever Pin Slide Bar Spring
200394C	14198	Tension Release Driving Lever Set Screw
210951	11610	Tension Release Washer
202407	10881	" Spring
200625F	11610	" Stud with 204925
200661C	14198	" " Set Screw
204925	11610	" " Washer
201572B	10881	" Thumb Nut
210953	11610	Tension complete, Nos. 200625F, 201572B, 202407, 202682, 207964, 210951 and 244007

No.	Plate	Name
202682	11610	Thread Controller Spring
210952	11610	" " " Stop
200167E	11610	" " " " Screw
202412	14199	" Guide
210955	11610	" " (upper)
200582H	11610	" " Screw (2)
204329	—	" Oiler (felt)
237770	14199	" " Bracket with 204329 ..
200582H	11610	" " " Screw
210956	11610	" Retainer Bracket with 200397H
200582H	11610	Thread Retainer Bracket Screw (2)
202091	14199	" " Sleeve
210993	11610	" " "
202092	14199	" " Spring
223844	14199	" " "
204058	14199	" " Stud
210957	11610	" " "
210958	11610	" " " Collar
200366H	14199	" " " Set Screw
200397H	11610	" " " " "
210959	11610	Thread Retainer (lower) complete, Nos. 210956 to 210958, 210993 and 223844
204059	—	Thread Retainer (upper) complete, Nos. 202091, 202092 and 204058 ..
237940	—	Throat Plate Body, for trimming opposite the needle and .040 and .050 in. to right of seam
237942	—	Throat Plate Knife Cutting Bar, .56 elongated needle hole, for needle sizes 12 and 13, trims opposite the needle and .040 in. to right of seam
200583H	14199	Throat Plate Knife Cutting Bar Screw
691E	14199	Throat Plate Screw (2)
237946	11200	Throat Plate complete, .56 elongated needle hole, for needle sizes 12 and 13, trims opposite the needle and .040 in. to right of seam, Nos. 237940, 237942 and two 200583H..
237744	14192	Vertical Shaft
237745	14199	" " Bevel Gear (lower)
205508	14199	" " " " " "
		Position Pin
235857	14181	Vertical Shaft Bevel Gear (upper) with 200374C and 200396C

No.	Plate	Name
200396c	11607	Vertical Shaft Bevel Gear (upper) Position Screw
200374c	14181	Vertical Shaft Bevel Gear (upper) Set Screw
237734	14181	Vertical Shaft Bushing (lower) ...
200346c	14199	" " " " Set Screw
237746	14192	Vertical Shaft Bushing (upper) ...
200362c	14398	" " " " Set Screw
237747	14199	Vertical Shaft Driving Gear with 200374c and 200396c
200396c	11607	Vertical Shaft Driving Gear Posi- tion Screw
200374c	14181	Vertical Shaft Driving Gear Set Screw
237754	14199	Vertical Shaft Oil Leader (lower) (brass)
237755	14199	Vertical Shaft Oil Leader (upper) (brass)

ACCESSORIES

FOR MACHINES NOS. 110w117 AND 110w122

No.	Plate	Name
200861b	14403	Bed Slide (back) Locking Thumb Screw
203470	14176	Bobbin (5)
*225482	-----	" Case Screw Driver Blade ...
*225483	-----	" " " " Handle ..
225497	14334	Bobbin Case Screw Driver com- plete, Nos. 225482 and 225483 ...
238632	14403	Feed Wheel Driving Pinion Spacing Washer
207805	14187	Knife
4822	14403	Roller Presser Hinge Screw Nut Wrench
16 x 4	-	Needle, two each, sizes 12, 14 and 16
228221	-----	Drip Pan with four wood screws $\frac{1}{2}$ in., No. 5
12361	14334	Machine Hinge Connection (2) ...
41400	14334	" Rest Pin (wood)
120342	14334	Oiler (copper plated) with 120343 ...
120343	14334	" Spout, $3\frac{1}{2}$ in. long
*225484	-----	Screw Driver Blade
*225485	-----	" Handle
225498	14334	Screw Driver complete (7 $\frac{1}{2}$ in. long), Nos. 225484 and 225485 ...
225554	14334	Wrench (steel)

BOBBIN WINDER

Swing Automatic, Right Hand

225453	10884	Frame with 202277 and 225438
225454	10884	" Hinge Pin
202277	-----	" Oil Packing (wick)
225438	10884	" " Well Cap
225455	10884	" Spring
225456	10884	" " Plunger
202473	10884	Pulley with 200380c
200380c	14398	" Set Screw
225381	10884	Spindle
225444	10884	Stop Latch
200056c	10884	" " Screw
225458	10884	" " Thumb Lever

No.	Plate	Name
225459	10884	Stop Latch Thumb Lever Hinge Stud
225459	10884	Stop Latch Thumb Lever Joint Stud
202478	10884	" " Trip Lever
200299 _U	10884	" " " " Hinge Screw
225461	10881	Tension Bracket with 201499 _B
200082 _D	10881	" " Screw
228026	10884	" " " Washer
2102	10881	" Disc
202407	10881	" Spring
201499 _B	10881	" Stud
201572 _B	10881	" " Thumb Nut
225462	10881	Bobbin Winder Tension Bracket complete, Nos. 201572 _B , 202407, 225461 and two 2102
225433	10885	Bobbin Winder and Tension Bracket Base
225382	10885	Universal Bobbin Winder complete, Nos. 200056 _E , 200082 _D , 200299 _U , 202473, 202478, 225381, 225433, 225444, 225453 to 225456, 225458, 225462, 228026, two each 225459 and wood screws $\frac{3}{4}$ in., No. 12, R.H.B.

KNEE LIFTER

2763	14407	Rock Shaft
7539	14407	" " Hanger (back) with two wood screws 1 in., No. 10 ..
20093	14407	Rock Shaft Hanger (front) with two wood screws 1 in., No. 10 ..
228562	14407	Rock Shaft Knee Arm
228563	—	Rock Shaft Knee Arm complete, Nos. 2766, 2767 and 228562
2766	14407	Rock Shaft Knee Arm Hub with 356 _C
356 _C	14407	Rock Shaft Knee Arm Hub Set Screw
2767	14407	Rock Shaft Knee Plate with 356 _C ..
228255	14407	" " " " Counterbalance Spring
356 _C	14407	Rock Shaft Knee Plate Set Screw ..
228238	14407	" " Lifting Lever with 356 _C ..
228239	—	" " " " 228238 with 8073, 204225, 228240 and 228241 ..
228240	14407	Rock Shaft Lifting Lever Rod (3 in. long)

No.	Plate	Name
200529 _C	14407	Rock Shaft Lifting Lever Rod Set Screw
228241	14407	Rock Shaft Lifting Lever Rod Swivel with 200529 _C
204225	14407	Rock Shaft Lifting Lever Rod Swivel Spring
8073	14407	Rock Shaft Lifting Lever Rod Swivel Spring Plunger
356 _C	14407	Rock Shaft Lifting Lever Set Screw ..
2770	14407	" " Stop Dog with 356 _C ..
356 _C	14407	" " " " Set Screw ..
228243	14407	Rock Shaft complete, Nos. 2763, 7539, 20093, 228239, 228255, 228563 and two 2770

(Other Knee Lifter parts are listed with parts of machine head.)

FEED GEARS

238605	—	Feed Wheel Driving Gear (for 12 stitches)
238606	—	Feed Wheel Driving Gear (for 14 stitches)
238607	—	Feed Wheel Driving Gear (for 15 stitches)
238608	—	Feed Wheel Driving Gear (for 16 stitches)
238609	14403	Feed Wheel Driving Gear (for 17½ stitches)
238610	—	Feed Wheel Driving Gear (for 19 stitches)
238611	—	Feed Wheel Driving Gear (for 21 stitches)
238612	—	Feed Wheel Driving Gear (for 23 stitches)
238618	—	Feed Wheel Driving Pinion (for 12 stitches)
238619	—	Feed Wheel Driving Pinion (for 14 stitches)
238620	—	Feed Wheel Driving Pinion (for 15 stitches)
238621	—	Feed Wheel Driving Pinion (for 16 stitches)

No.	Plate	Name
238622	14403	Feed Wheel Driving Pinion (for 17 1/2 stitches)
238623	-----	Feed Wheel Driving Pinion (for 19 stitches)
238624	-----	Feed Wheel Driving Pinion (for 21 stitches)
238625	-----	Feed Wheel Driving Pinion (for 23 stitches)

FEED WHEELS

237707	14190	Feed Wheel
237767	14382	" " (coarse)
237771	14382	" " (knurled)
238523	14382	" "

GUIDES

FOR MACHINE No. 110w122

237902	14188	Guide Bed with 26550
200397II	11610	" " Adjusting Screw
237938	14188	" Finger to trim back of needle
26756	14188	" " " " opposite the needle
26543	-----	Guide Finger Carrier
1073J	14188	" " " " Regulating Thumb Screw

No.	Plate	Name
1550J	14188	Guide Finger Carrier Regulating Thumb Screw Nut
50009J	14188	Guide Finger Carrier Screw
35777	14188	" " " " Friction Plate
26544	14188	Guide Finger Carrier complete, Nos. 1075E, 26543, 26546 and three 2523
26546	-	Guide Finger Position Plate
2523	14188	" " " " Rivet
219J	14188	" " Screw
1075E	14199	" Regulating Screw Stud
1536J	14188	" " Thumb Nut
200907E	14188	" Screw
26547	14188	" Slide
26548	14188	" " Latch
26549	14188	" " " Cap with 2081
50169J	14188	" " " " Screw
2975	14188	" " " Spring
2081	14188	" " " Stop Pin
26550	-	" " " Stud
26551	14188	" " Spring
1074E	14188	" " Stop Stud
237903	14188	" Swing Base with two 200397II
200246E	14187	" " " Hinge Screw
201525E	14187	" " " " " Nut
225708	14187	" " " Spring
237905	14190	Guide (adjustable), for trimming back of needle, complete, Nos. 219J, 1073J, 1074E, 1536J, 1550J, 2975, 26544, 26547 to 26549, 26551, 35777, 50009J, 200246E, 201525E, 225708, 237902, 237903, 237938, two each 50169J and 200907E
237904	---	Guide (adjustable), for trimming opposite the needle, complete, Nos. 219J, 1073J, 1074E, 1536J, 1550J, 2975, 26544, 26547 to 26549, 26551, 26756, 35777, 50009J, 200246E, 201525E, 225708, 237902, 237903, two each 50169J and 200907E

From the library of: Diamond Needle Corp

THROAT PLATES

FOR MACHINE No. 110w117

No.	Plate	Name
237823	14200	Throat Plate, 53 elongated needle hole, for needle sizes 14 and 15, with 200178b, 200587b, 211416 and 211426, trims opposite the needle and .045, .060 and .085 in. to right of seam

FOR MACHINE No. 110w122

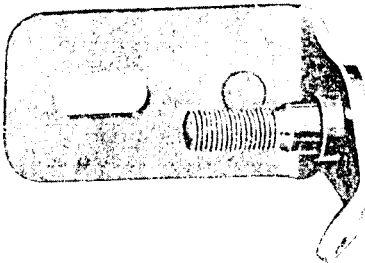
237940	---	Throat Plate Body, for trimming opposite the needle and .040 and .050 in. to right of seam, for 237946 and 237947
237941	---	Throat Plate Body, for trimming opposite the needle and .060 and .075 in. to right of seam, for 237948 and 237949
237950	---	Throat Plate Body, for trimming back on needle and .015 and .025 in. to right of seam, for 237956 and 237957
237951	---	Throat Plate Body, for trimming back of needle and .040 and .050 in. to right of seam, for 237958 ..
237942	14200	Throat Plate Knife Cutting Bar, 56 elongated needle hole, for needle sizes 12 and 13, trims opposite the needle and .040 in. to right of seam, for 237946
237943	---	Throat Plate Knife Cutting Bar, 56 elongated needle hole, for needle sizes 12 and 13, trims opposite the needle and .050 in. to right of seam, for 237947
237944	---	Throat Plate Knife Cutting Bar, 56 elongated needle hole, for needle sizes 12 and 13, trims opposite the needle and .060 in. to right of seam, for 237948

No.	Plate	Name
237945	---	Throat Plate Knife Cutting Bar, 56 elongated needle hole, for needle sizes 12 and 13, trims opposite the needle and .075 in. to right of seam, for 237949
237952	---	Throat Plate Knife Cutting Bar, 56 elongated needle hole, for needle sizes 12 and 13, trims back of needle and .015 in. to right of seam, for 237956
237953	---	Throat Plate Knife Cutting Bar, 56 elongated needle hole, for needle sizes 12 and 13, trims back of needle and .025 in. to right of seam, for 237957
237954	14200	Throat Plate Knife Cutting Bar, 56 elongated needle hole, for needle sizes 12 and 13, trims back of needle and .040 in. to right of seam, for 237958
237946	14200	Throat Plate complete, 56 elongated needle hole, for needle sizes 12 and 13, trims opposite the needle and .040 in. to right of seam, Nos. 237940, 237942 and two 200583u. .
237947	---	Throat Plate complete, 56 elongated needle hole, for needle sizes 12 and 13, trims opposite the needle and .050 in. to right of seam, Nos. 237940, 237943 and two 200583u. .
237948	---	Throat Plate complete, 56 elongated needle hole, for needle sizes 12 and 13, trims opposite the needle and .060 in. to right of seam, Nos. 237941, 237944 and two 200583u. .
237949	---	Throat Plate complete, 56 elongated needle hole, for needle sizes 12 and 13, trims opposite the needle and .075 in. to right of seam, Nos. 237941, 237945 and two 200583u. .
237956	---	Throat Plate complete, 56 elongated needle hole, for needle sizes 12 and 13, trims back of needle and .015 in. to right of seam, Nos. 237950, 237952 and two 200583u. .
237957	---	Throat Plate complete, 56 elongated needle hole, for needle sizes 12 and 13, trims back of needle and .025 in. to right of seam, Nos. 237950, 237953 and two 200583u. .

Throat Plates

No.	Plate	Name
237958	14200	Throat Plate complete, 56 elongated needle hole, for needle sizes 12 and 13, trims back of needle and .040 in. to right of seam. Nos. 237954, 237954 and two 290583u.

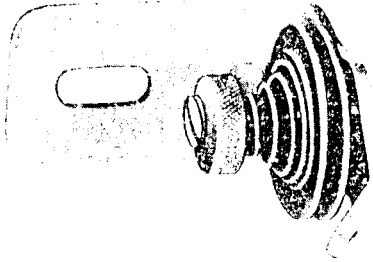
225461



200082 202104



225462



202087



201476



**ILLUSTRATIONS OF PARTS
FOR
MACHINES**

Nos. 110w117 and 110w122

From the library of: Diamond Needle Corp

PLATE 10884—FULL SIZE

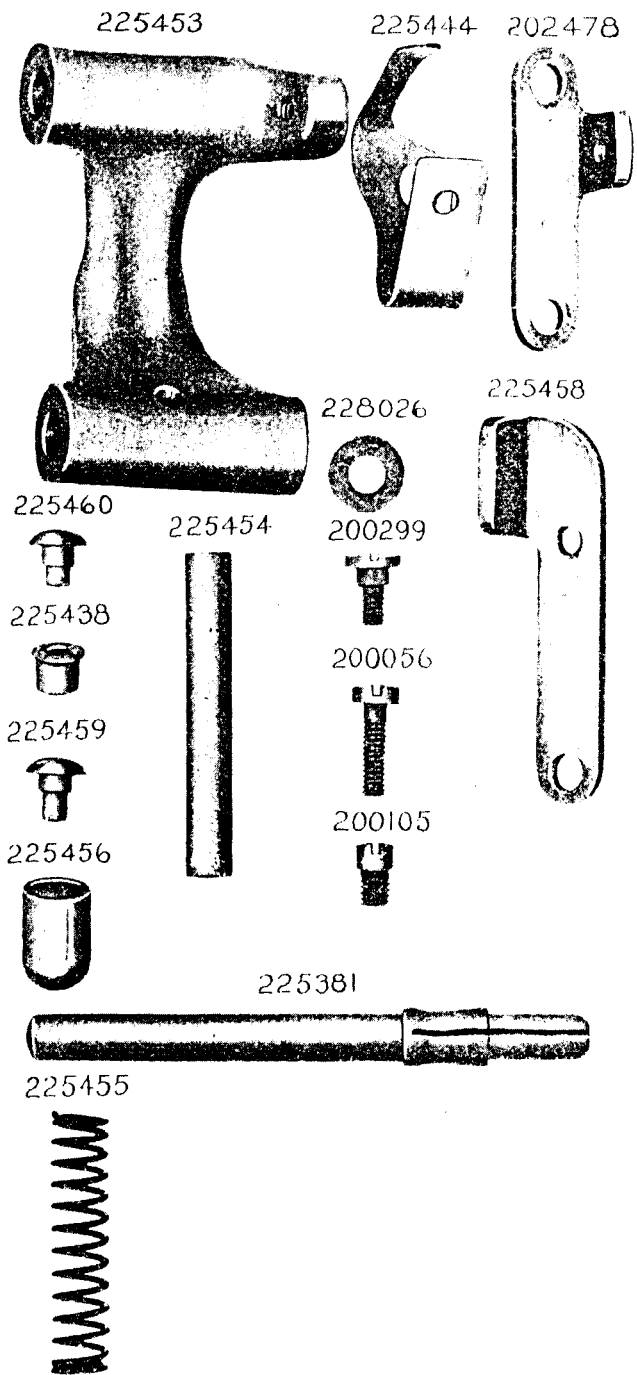
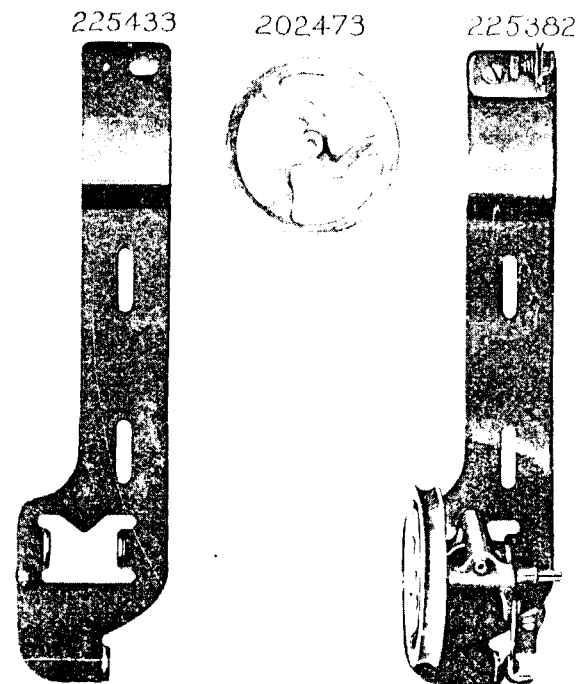


PLATE 10885—ONE-FOURTH SIZE



From the library of: Diamond Needle Corp

PLATE 11607--FULL SIZE

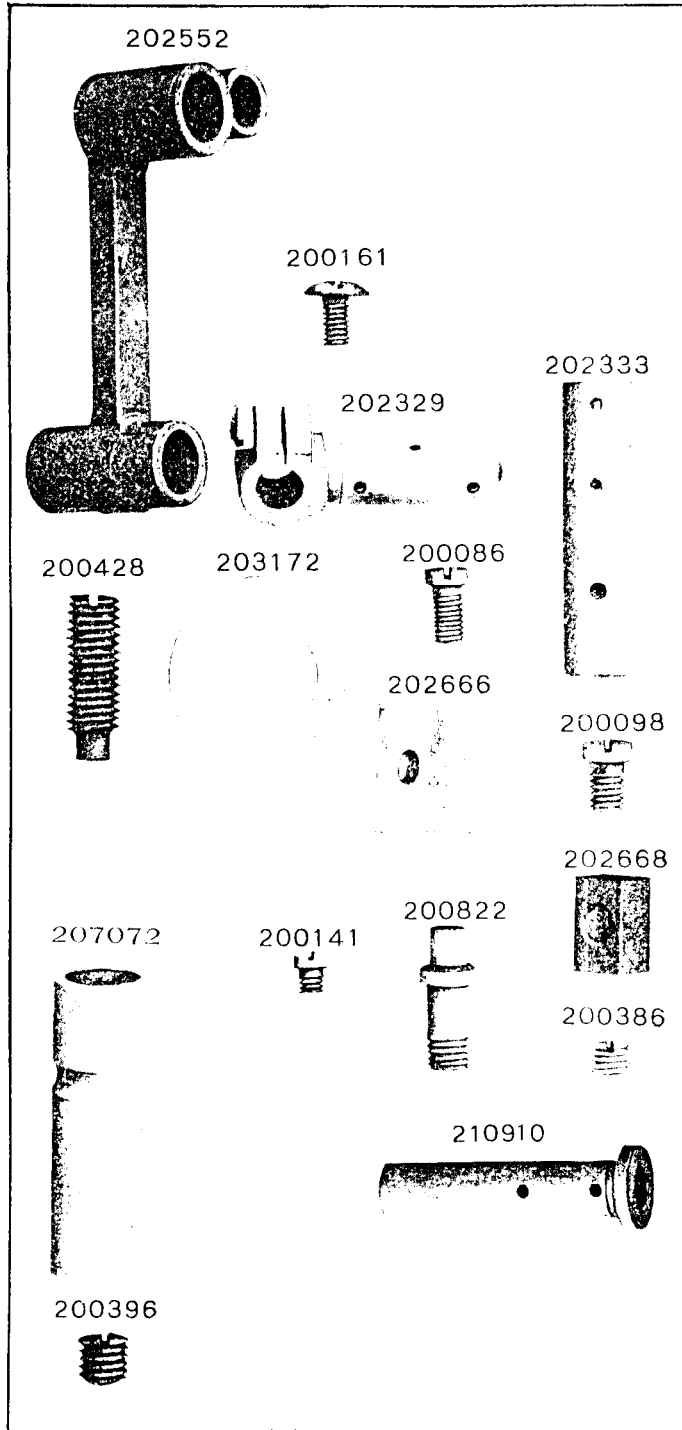
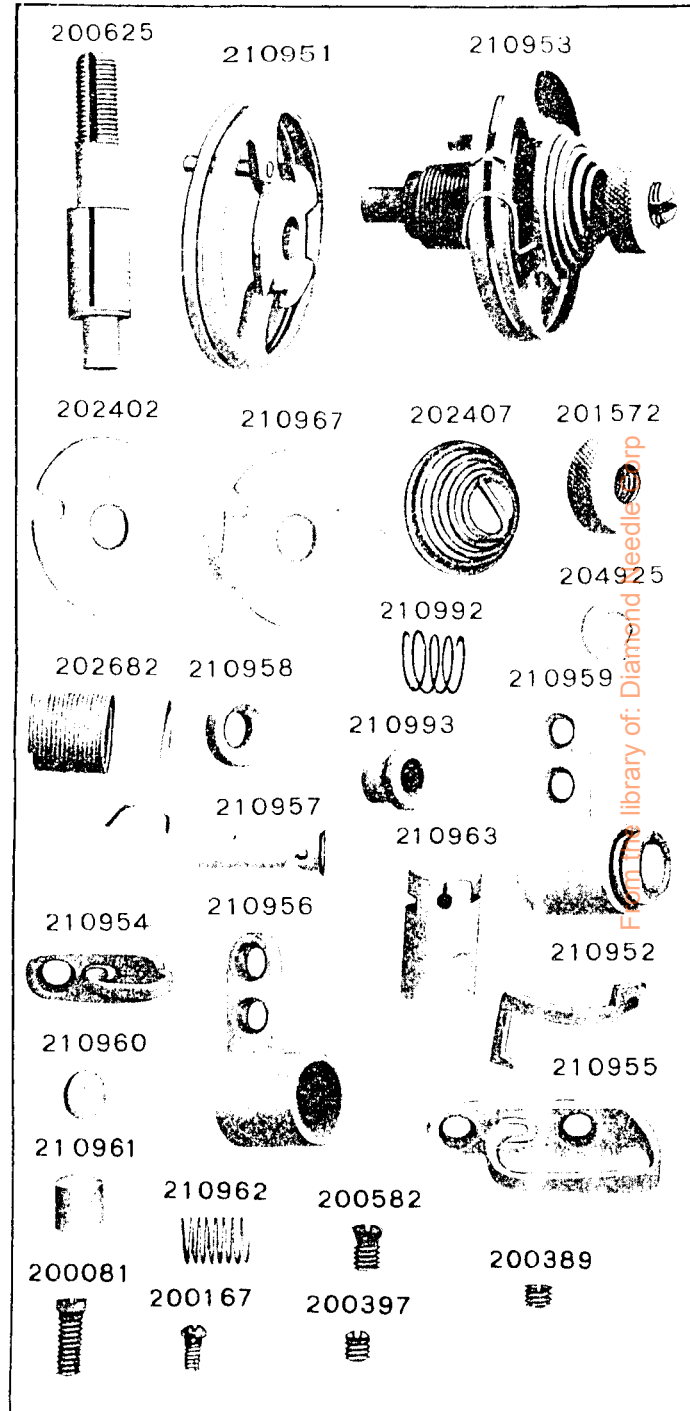


PLATE 11610--FULL SIZE



From the library of: Diamond Needle Corp

PLATE 14176—FULL SIZE

200278 202248 200071 202036 200338

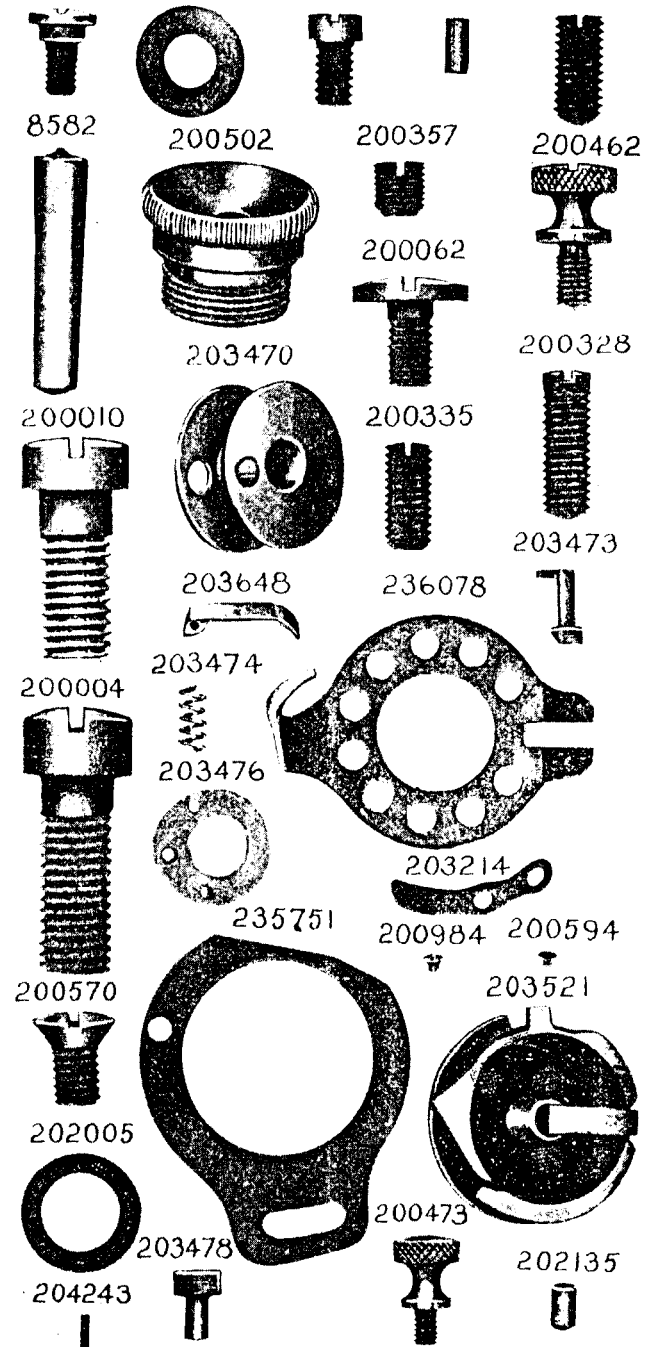
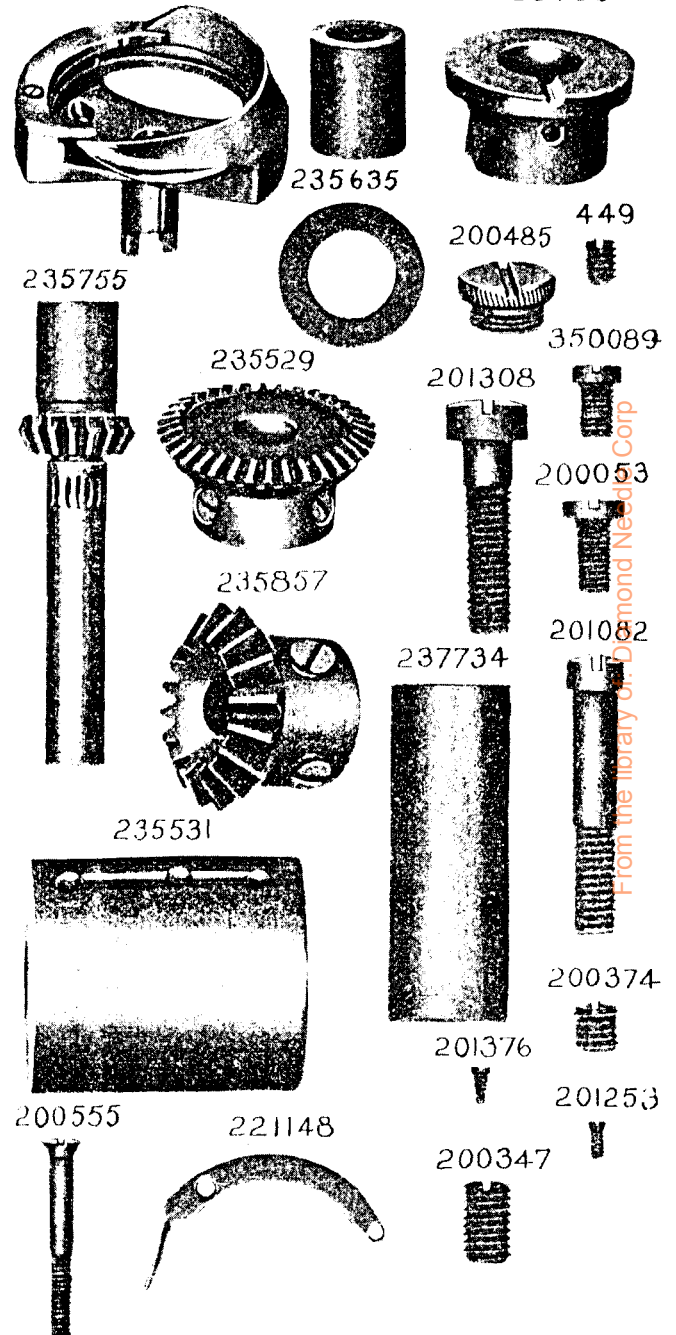


PLATE 14181—FULL SIZE

237726 235527 235756



From the library of Diamond Need Corp

PLATE 14187—FULL SIZE

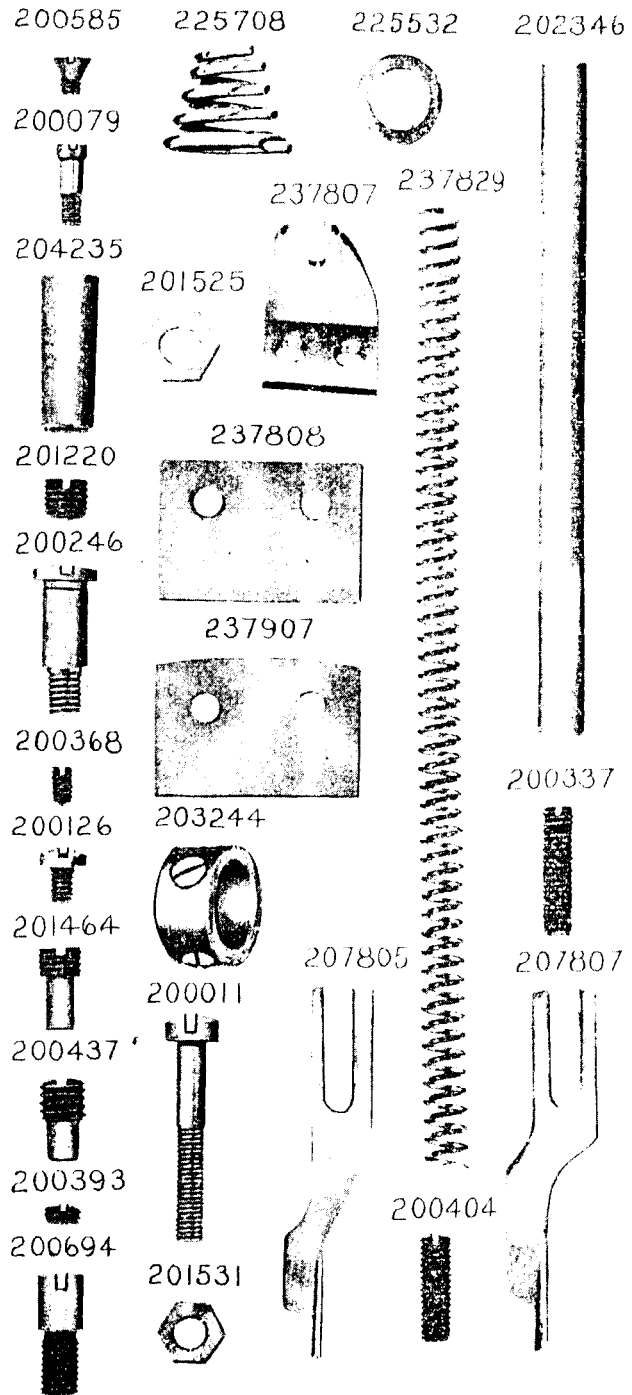


PLATE 14188—FULL SIZE

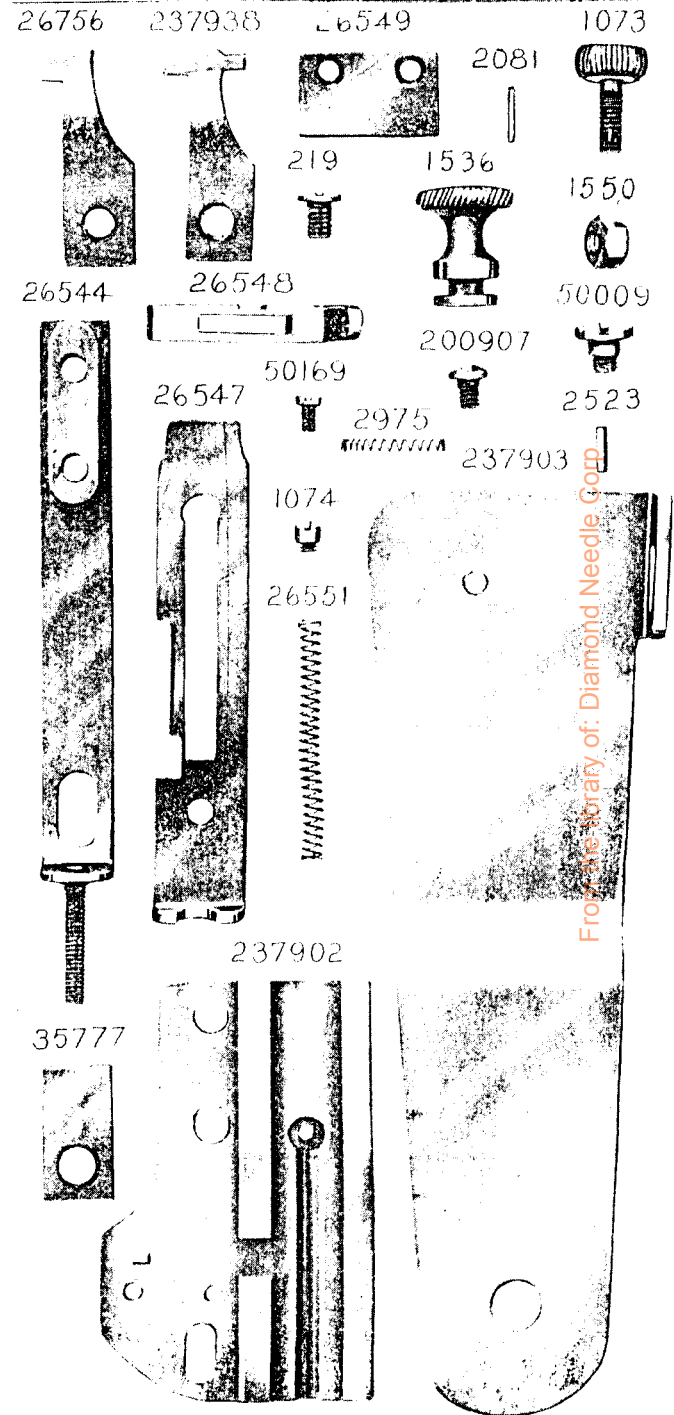
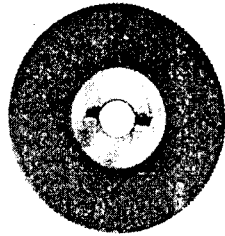


PLATE 14190—ONE-HALF SIZE

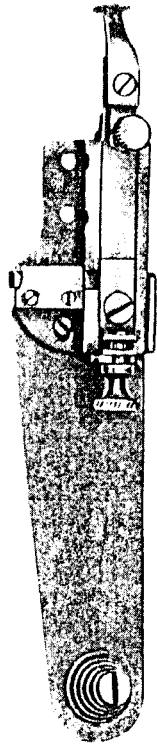
237707

237767 237728

237766



237905



221417



237806



237932



208490



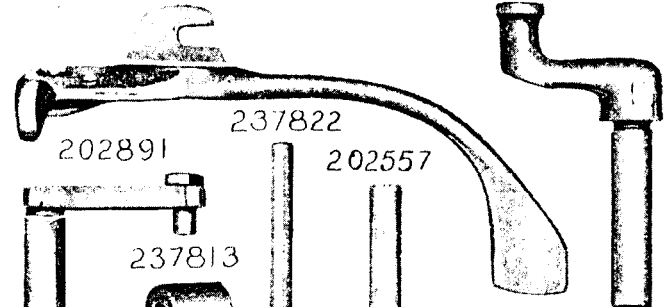
202890



PLATE 14192—ONE-HALF SIZE

237812

202667

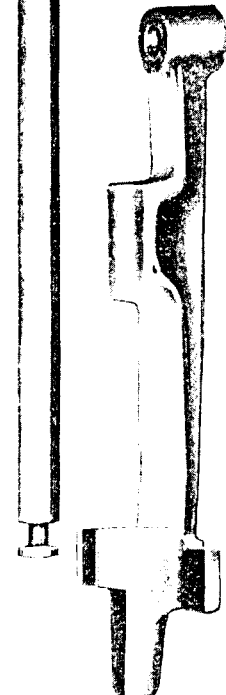


237822

202891

202557

237813



237744

202899

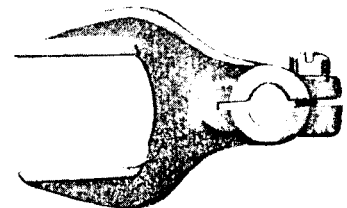
237746



202692



237739



From the library of: Diamond Needle Corp

PLATE 14193—FULL SIZE

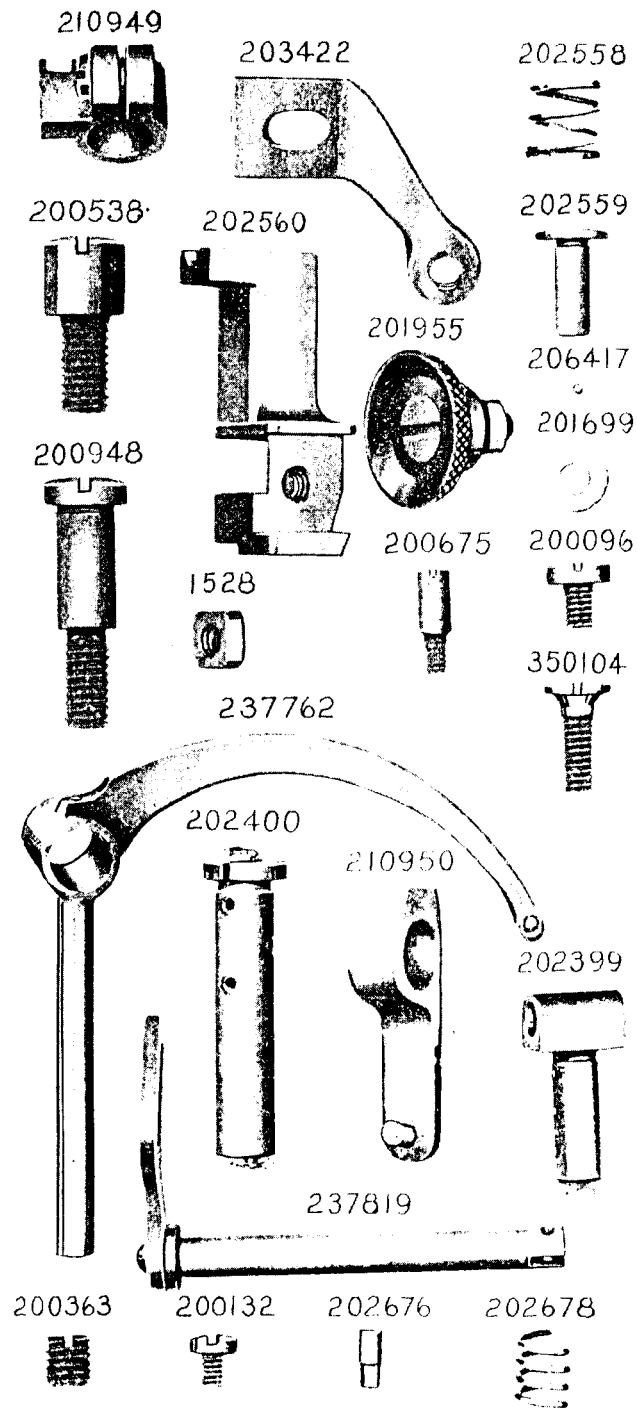
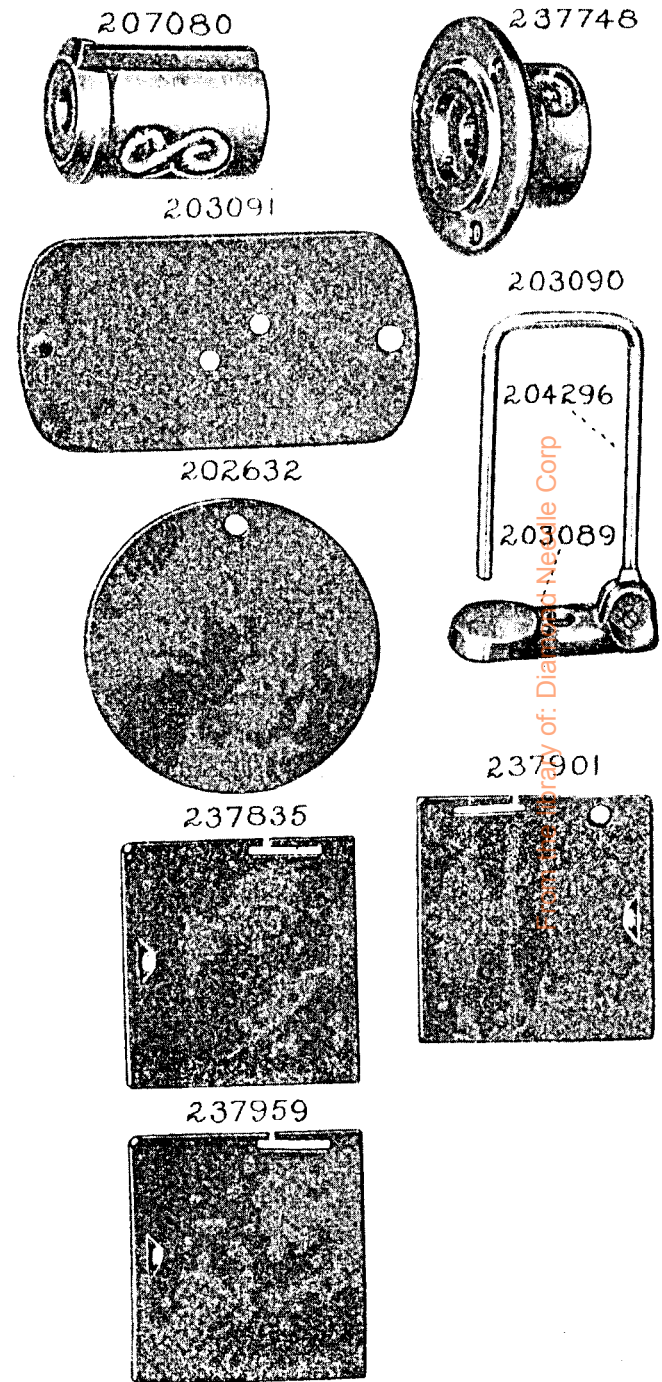


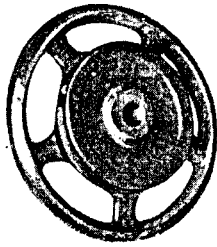
PLATE 14196—ONE-HALF SIZE



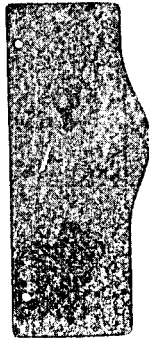
Library of: Dial and Needle Corp

PLATE 14197—ONE-FOURTH SIZE

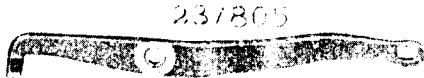
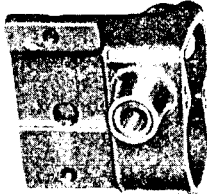
237802 238627 223842 237804



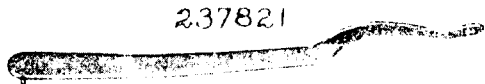
237729



237735



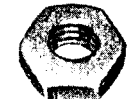
237805



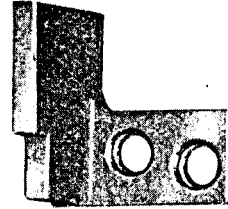
237821

PLATE 14198—FULL SIZE

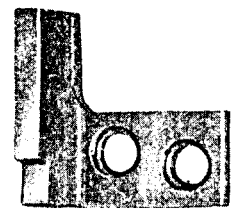
201666 237809 237908



200382



237810



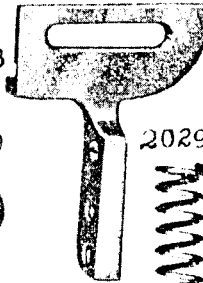
237933



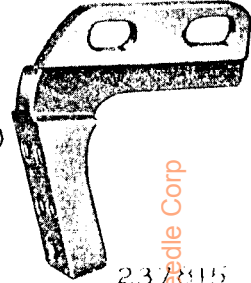
201387



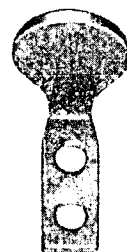
200898



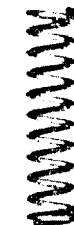
202900



237939

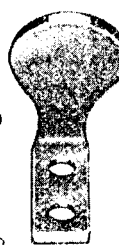


237811

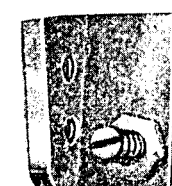


237910

200076



200653



202338



200373



350129



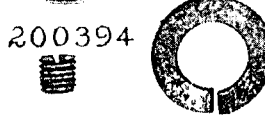
200352



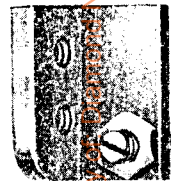
200394



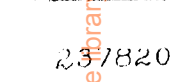
200061



206608



237815



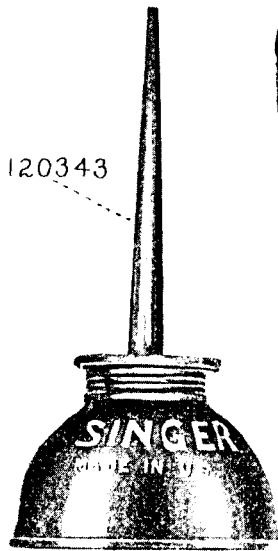
237820



From the Laboratory of the U.S. Army Ordnance Corps

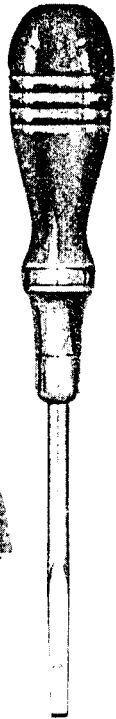
PLATE 14334—ONE-HALF SIZE

120342



120343

225498



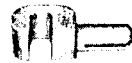
225497



225554



12361

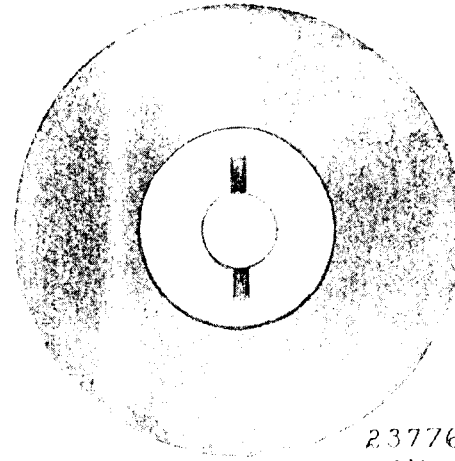


41400

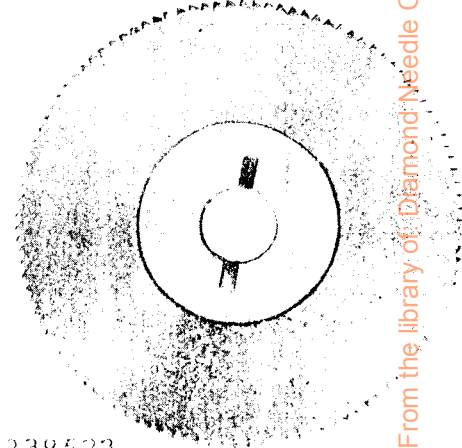


PLATE 14382—FULL SIZE

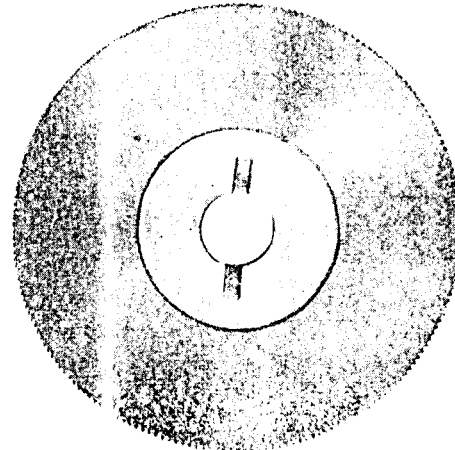
237771



237767



238523



From the library of Diamond Needle Corp

PLATE 14398--FULL SIZE

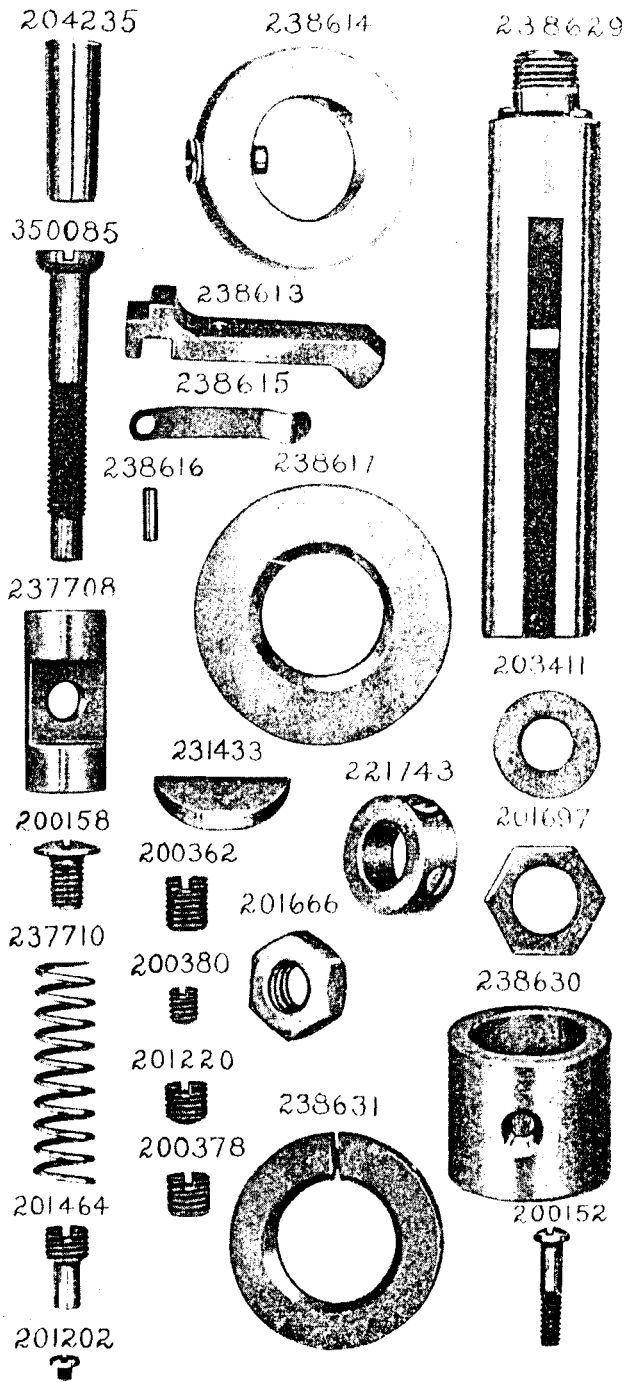
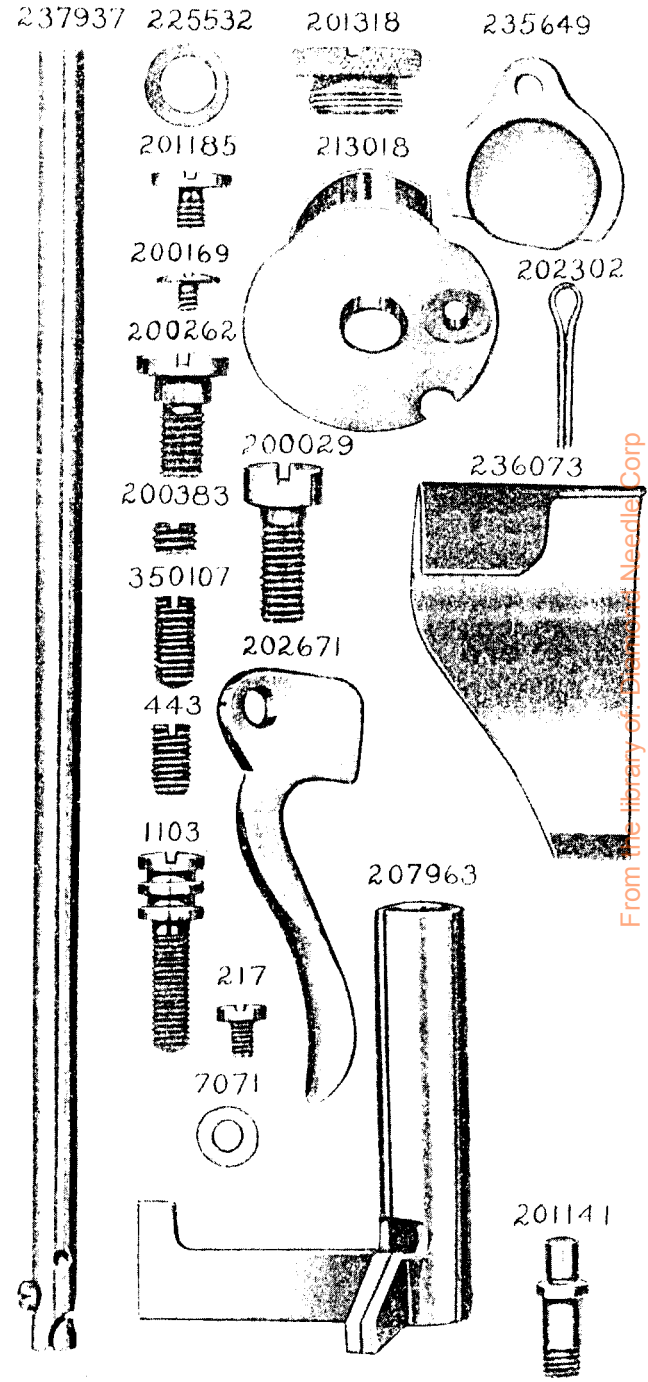


PLATE 14399--FULL SIZE



From the library of Lewis & Needle Corp

PLATE 14400-ONE-HALF SIZE

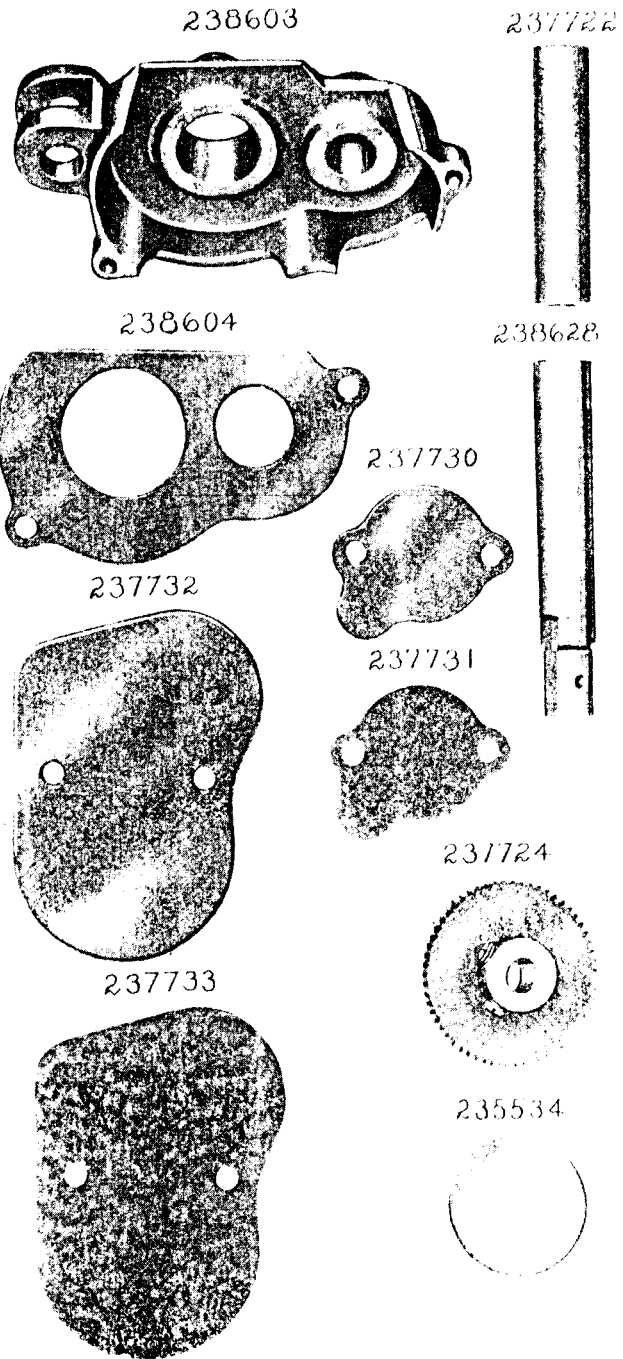
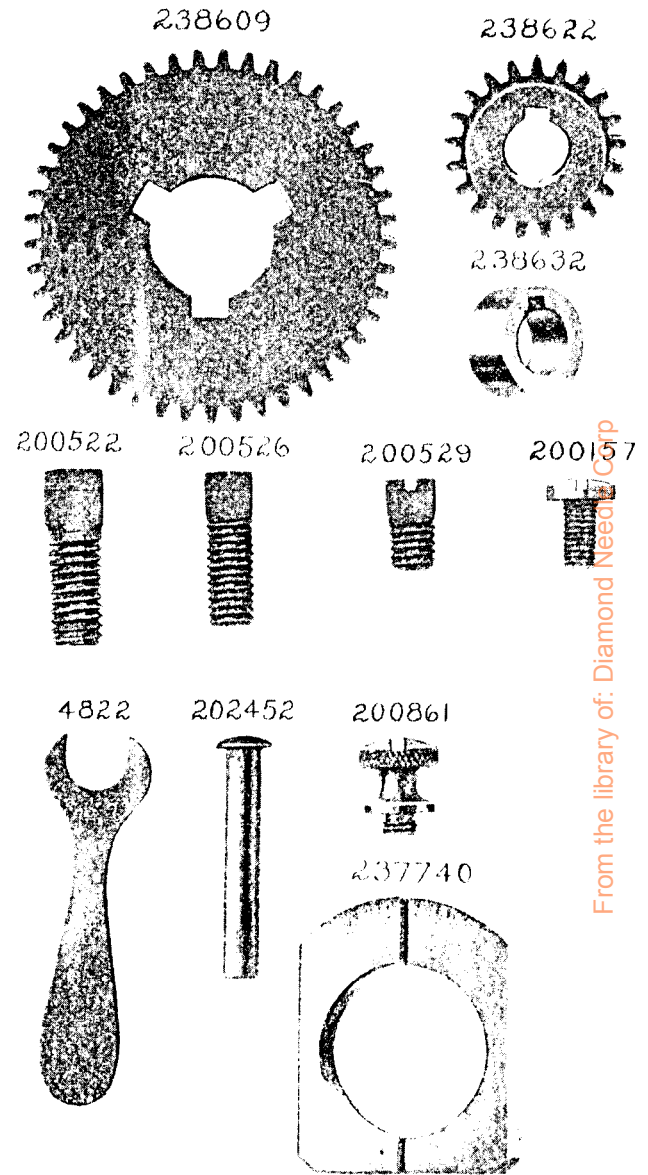
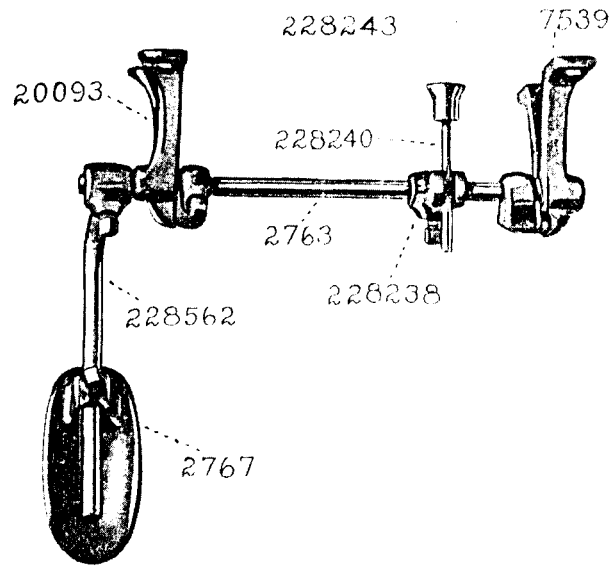


PLATE 14403-FULL SIZE



From the library of: Diamond Need Co. Inc.

PLATE 14407—ONE-FOURTH SIZE



FULL SIZE

